

6-GFM-90Ah

Valve-regulated Lead Acid Battery Specification

Features

- Maintenance free
- Safety and no leakage
- Excellent recharge and discharge performance
- Low self-discharge rate
- Adapt to high or low temperature
- Good deep discharge performance
- Longer cycle life



Specification

Rated Voltage	12V
Numbers of cells	6 Cells
Capacity	90Ah@10hr-rate to 1.80V per cell @25°C
Weight	27.5kg
Internal Resistance	Approx. 5 mΩ
Terminal	F8
Max. Discharge Current	1350A(5s)
Short Circuit Current	4500A
Max. Charging Current	22.5A
Reference Capacity	C10 90.0AH C3 69.0AH C1 49.7AH
Design Life	10~15 years
Float Charging Voltage	13.6 V~13.8 V @ 25°C Temperature Compensation: -20mV/°C/Cell
Cycle Use Voltage	14.4 V~14.9 V @ 25°C Temperature Compensation: -30mV/°C/Cell
Operating Temperature Range	Discharge: -15°C~50°C Charge: 0°C~40°C Storage: -15°C~40°C
Normal Operating Temperature Range	25°C±5°C
Self Discharge	Less than 3% at 25°C per month
Container Material	A.B.S. UL94-HB, UL94-V0 Optional.

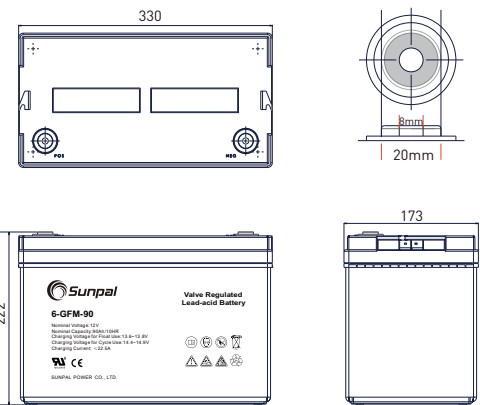

Length	330±2mm (13.0 inches)
Width	173±1mm (6.8 inches)
Height	217±1mm (8.5 inches)
Total Height	222±1mm (8.7 inches)

Constant Current Discharge Characteristics: A(25°C)

F.V/Time	5min	10min	15min	20min	30min	45min	1h	3h	5h	10h	20h
1.80V/cell	206.8	154.7	124.4	101.8	80.8	60.3	47.5	23.0	15.1	9.0	4.68
1.75V/cell	233.1	170.0	135.9	109.5	83.9	62.5	49.7	23.4	15.5	9.1	4.73
1.70V/cell	256.7	185.3	145.1	115.1	87.3	65.0	51.3	24.1	15.9	9.2	4.82
1.65V/cell	283.1	200.0	154.3	122.3	92.1	66.7	53.0	25.1	16.3	9.4	4.88
1.60V/cell	312.2	217.1	165.0	130.3	97.2	69.5	54.9	25.9	16.9	9.5	4.91

Constant Power Discharge Characteristics: WPC(25°C)

F.V/Time	5min	10min	15min	20min	30min	45min	1h	3h	5h	10h	20h
1.80V/cell	374.0	282.5	229.1	189.1	151.6	114.9	91.2	44.6	29.5	17.8	9.26
1.75V/cell	412.7	305.4	247.1	201.5	156.1	118.1	95.0	45.2	30.2	17.9	9.33
1.70V/cell	441.9	325.3	260.2	210.2	161.6	122.4	97.6	46.4	30.9	18.1	9.51
1.65V/cell	480.4	347.9	274.5	221.6	169.1	124.3	100.2	48.1	31.6	18.4	9.62
1.60V/cell	517.6	369.1	288.7	233.5	177.2	128.9	103.2	49.4	32.5	18.6	9.66

6-GFM-90Ah

Valve-regulated Lead Acid Battery Specification

Charge Characteristics for Float Use @ 25°C/77°F

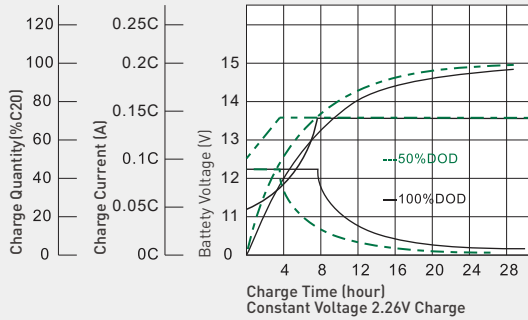

Discharge Characteristics at Various Rates @ 25°C/77°F

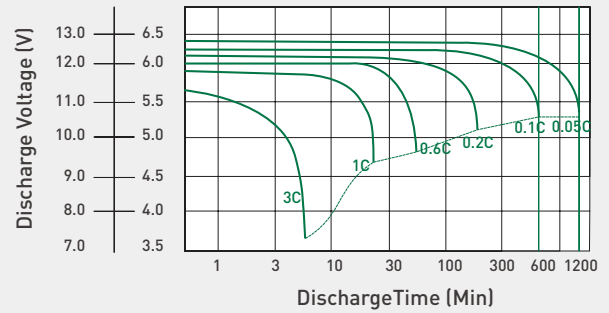

Cycle Life in Relation to Depth of Discharge

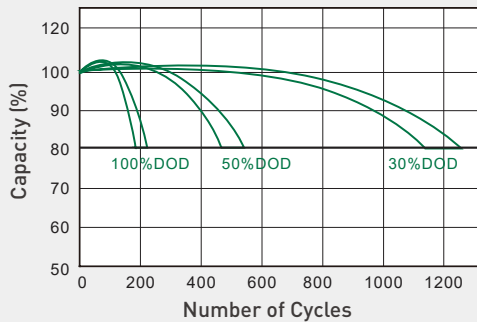

Float Service Life

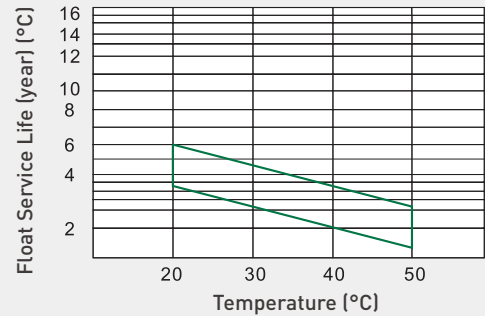

Temperature and Valid Capacity

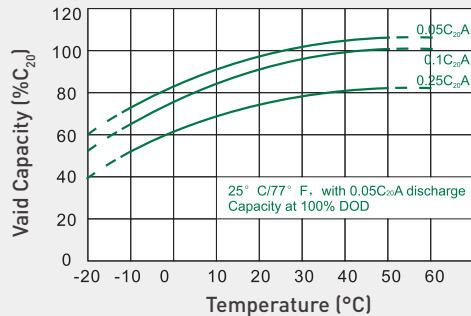

Self Discharge Characteristics

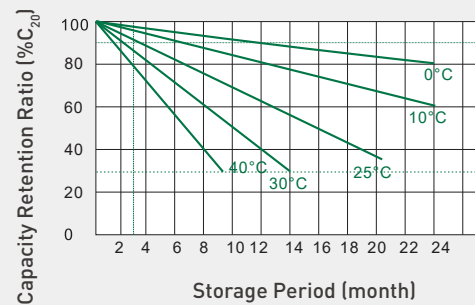

Capacity and Open Circuit Voltage

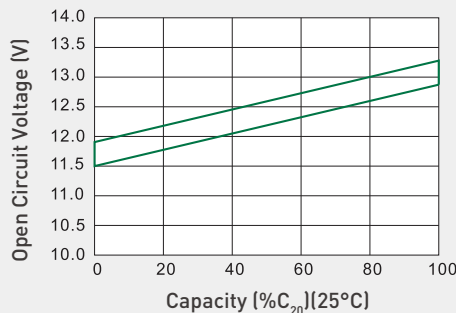

Relationship between Charging Voltage and Temperature

